

# Cellini panel

Installation manual

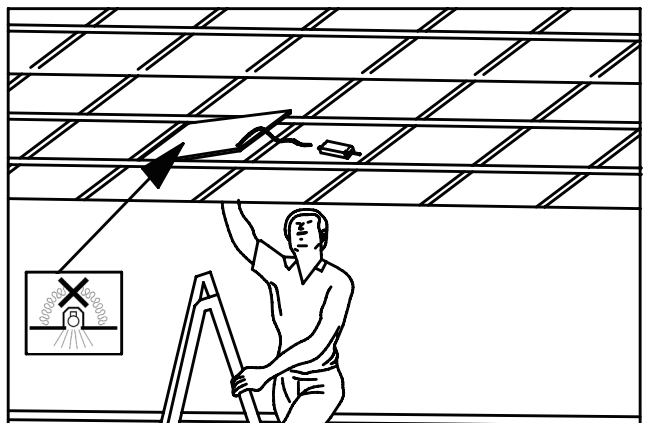

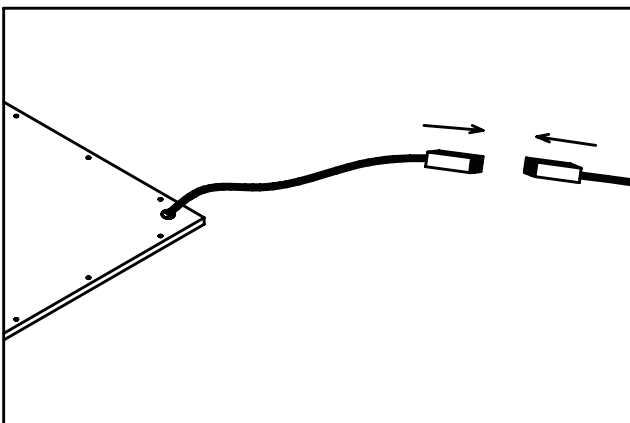
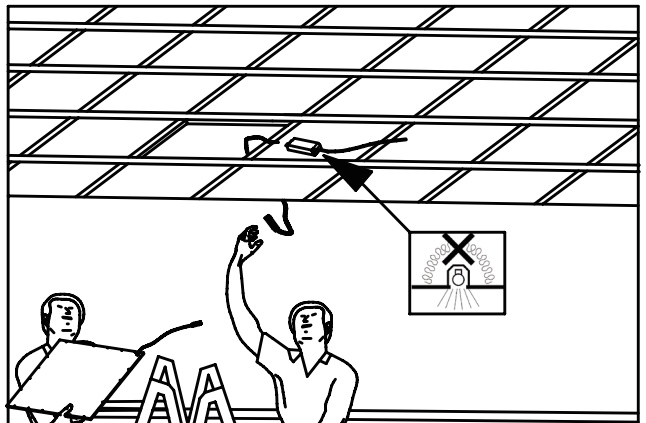
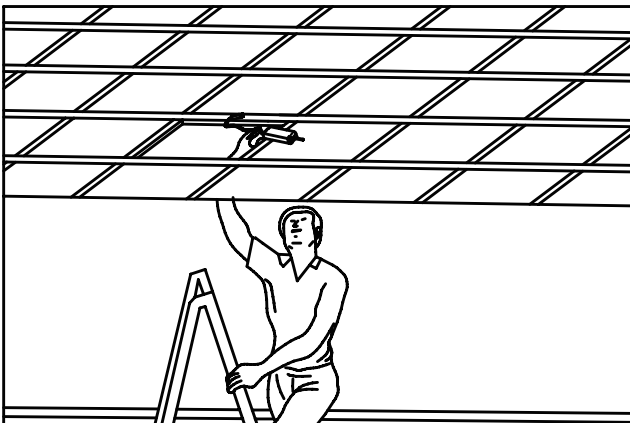
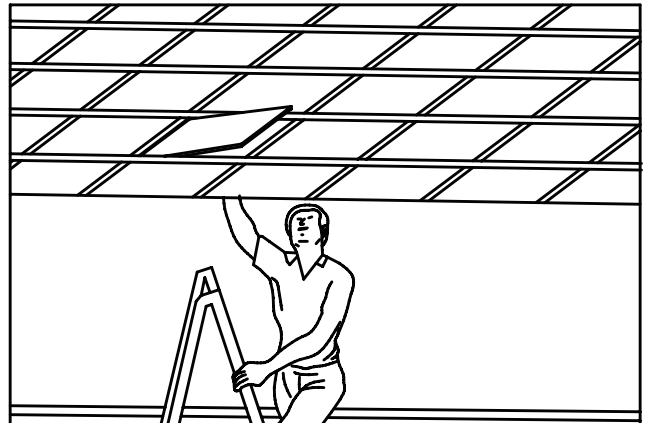
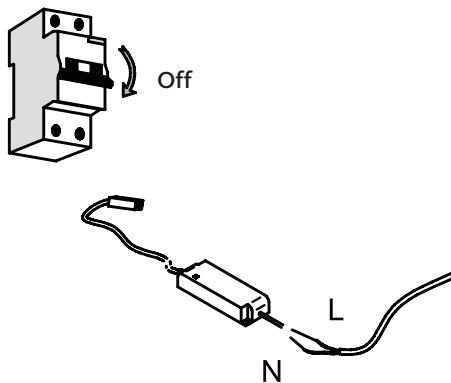
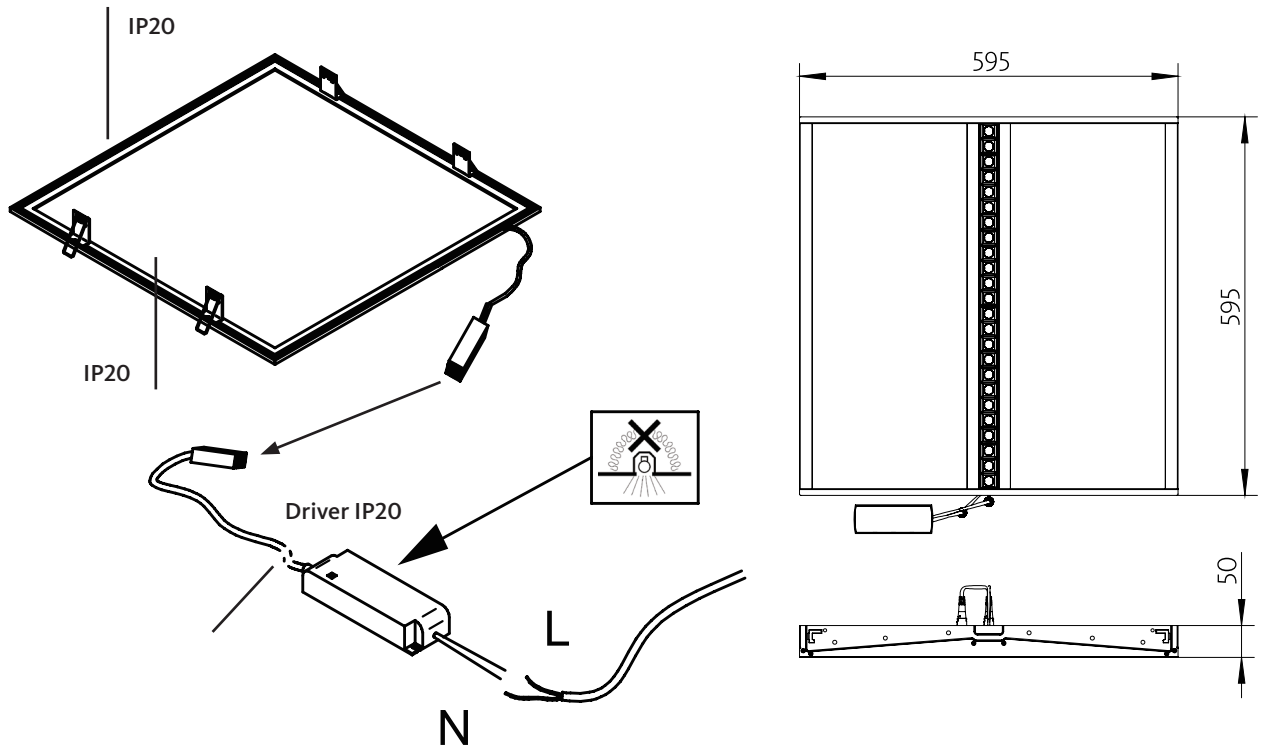

**Note:** If more than one channel - connect according to the markings on the cable.

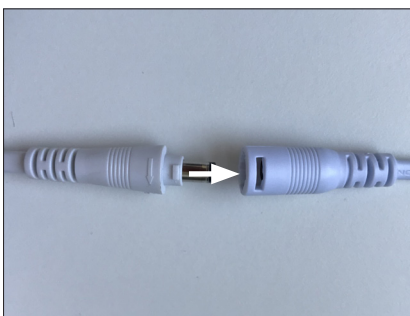

1: Put the plug in the jack.



2: Turn the plug.



3: Complete.