

PipeLED-C

Installation manual – PipeLED with fast connector

1

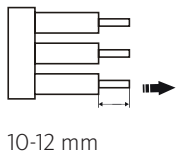
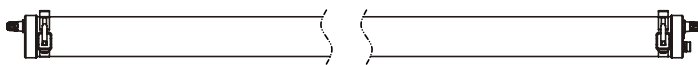

- 1: Used for cable e, 0,75-1,5 mm² (AWG 18#)
- 2: Solid cable end
- 3: Wire stripping 10-12 mm

2

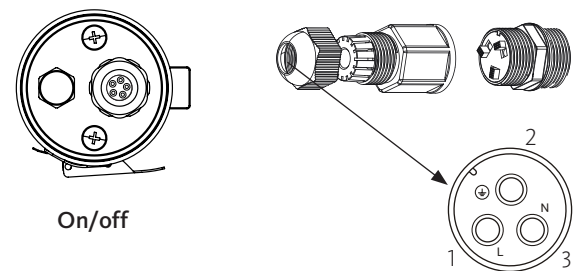
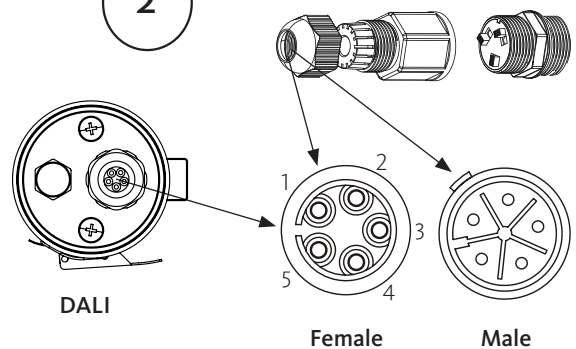

3

	DALI	ON/OFF	
Brown	L1	L1	1
Green/yellow	⊖	⊖	2
Blue	N	N	3
Black	DIM+/DA+	-	4
Grey	DIM-/DA	-	5

For better waterproof, kindly note belctips

- 1: For on/off version, ensure to use 6-9 mm cable to go wiring. For DALI version, ensure to use 10-14 mm cable to go wiring.
- 2: After going wire, use tool like spanner to make the connectors tight.

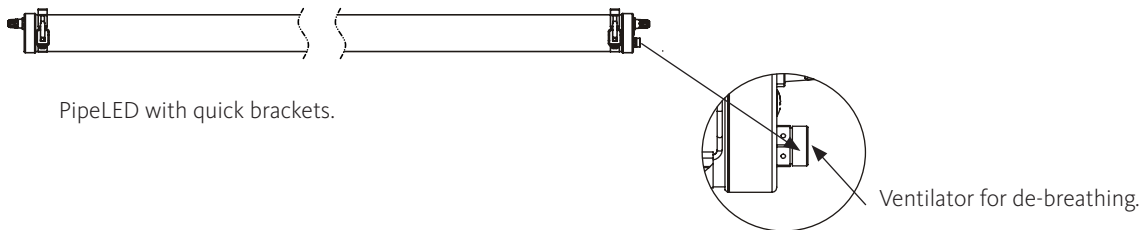

Ceiling installation

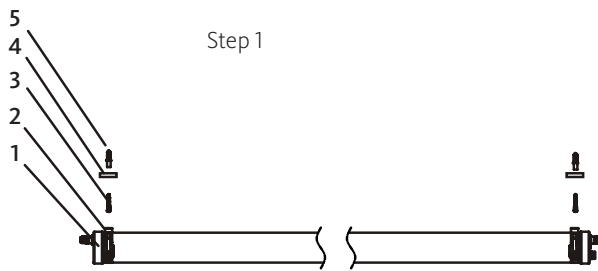

SPARE PARTS	QUANTITY	
PipeLED	1	1
Clips	2	2
Self-tapping screws	2	3
Rubber washers	2	4
Expansion plastic screws	2	5

Step 2

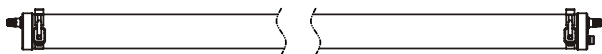

Disconnect the power, then connect wires on the end caps.

Step 3

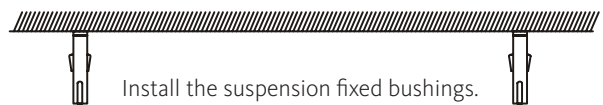

Step 4

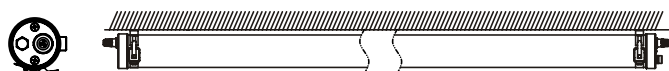

Install PipeLED light and adjust beam angle.

Series connection



POWER (W)	INPUT VOLTAGE (V)	MAXIMUM QUANTITY CONNECTING IN SERIES	INPUT VOLTAGE (V)	MAXIMUM QUANTITY CONNECTING IN SERIES	INPUT VOLTAGE (V)	MAXIMUM QUANTITY CONNECTING IN SERIES
20	230	46 pcs	110	16 pcs	277	41 pcs
30	230	30 pcs	110	11 pcs	277	27 pcs
36	230	25 pcs	110	10 pcs	277	26 pcs
45	230	20 pcs	110	7 pcs	277	18 pcs
50	230	18 pcs	110	6 pcs	277	16 pcs
60	230	15 pcs	110	5 pcs	277	13 pcs

Maintenance hints

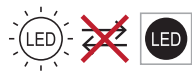

Non-replaceable light source.

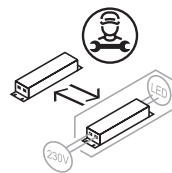

Replaceable control gear by a professional.